

CLIP-ON STRAIGHT JACK CRIMP TYPE

R120.237.500

CABLE 2.6/50 S

Series : **DIN 41626**

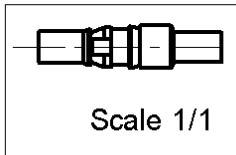
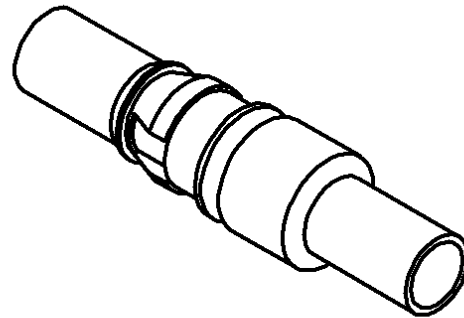
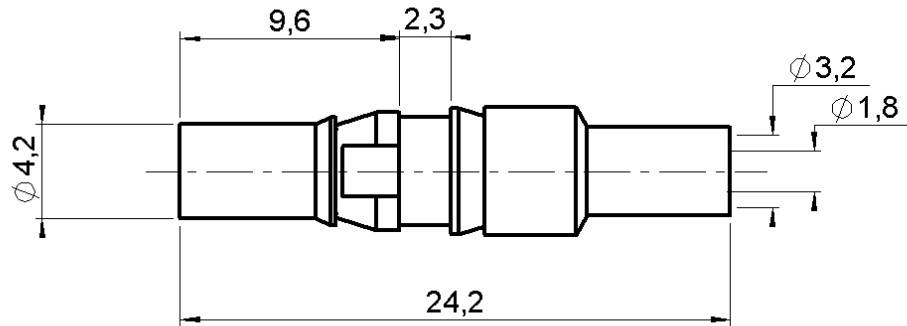

All dimensions are in mm.



COMPONENTS	MATERIALS	PLATINGS (μm)
BODY	BRASS	GOLD .
CENTER CONTACT	BERYLLIUM COPPER	GOLD .
OUTER CONTACT	-	-
INSULATOR	PTFE	-
GASKET	-	-
OTHERS PARTS	-	-
-	-	-
-	-	-

Issue : 0042 B

In the effort to improve our products, we reserve the right to make changes judged to be necessary.



CLIP-ON STRAIGHT JACK CRIMP TYPE

R120.237.500

CABLE 2.6/50 S

Series : **DIN 41626**

PACKAGING

Standard	Unit	Other
100	'W' option	Contact us

SPECIFICATION

ELECTRICAL CHARACTERISTICS

Impedance		50 Ω
Frequency		0-2 GHz
VSWR	1.35 +	0.000 x F(GHz) Maxi
Insertion loss		NA √F(GHz) dB Maxi
RF leakage	- (NA - F(GHz)) dB mini
Voltage rating		250 Veff Maxi
Dielectric withstanding voltage		750 Veff mini
Insulation resistance		5000 MΩ mini

CABLE ASSEMBLY

Stripping	a	b	c	d	e	f
mm	2.00	5.00	9.00	0.00	7.00	0.00

Assembly instruction :

Recommended cable(s)
 KX 22A
 RG 316
 RG 188

Cable retention

- pull off **40** N mini
- torque **NA** N.cm

MECHANICAL CHARACTERISTICS

Center contact retention		
Axial force – Mating end	10	N mini
Axial force – Opposite end	10	N mini
Torque	NA	N.cm mini

TOOLING

Part Number	Description	Hexagon
.	.	.
R282.211.000	CRIMPING TOOL	2.67
R282.235.003	CRIMPING DIES	2.67
R282.293.000	CRIMPING TOOL	-

Recommended torque		
Mating	NA	N.cm
Panel nut	NA	N.cm
Clamp nut	NA	N.cm
A/F clamp nut	0.000	mm

Mating life	100	Cycles mini
Weight	1.800	g

OTHERS CHARACTERISTICS

-

ENVIRONMENTAL

Operating temperature	-55/+155	° C
Hermetic seal	NA	Atm.cm3/s
Panel leakage	NA	

Issue : **0042 B**

In the effort to improve our products, we reserve the right to make changes judged to be necessary.



CLIP-ON STRAIGHT JACK CRIMP TYPE

R120.237.500

CABLE 2.6/50 S

Series : **DIN 41626**

COMPONENTS

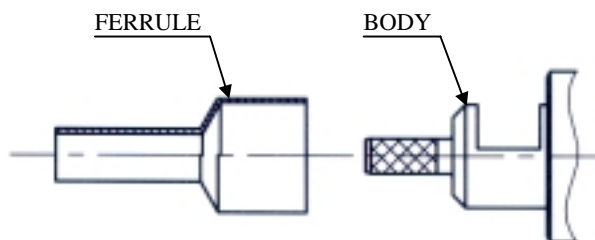

STRIPPING DIMENSIONS

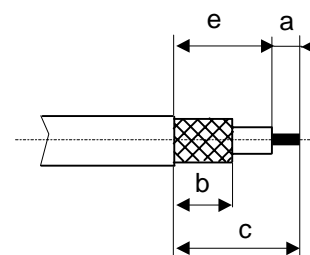

1



Slide the ferrule onto the cable.
Strip the cable.

3

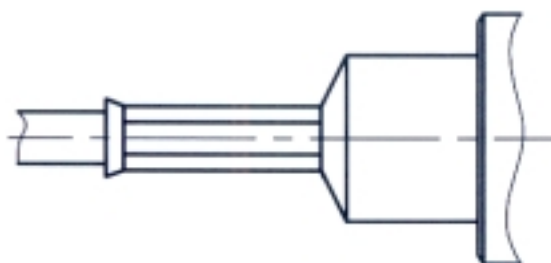

Crimp the ferrule with crimping tool (see connector TDS).
Cut the excess of braid if necessary.

2

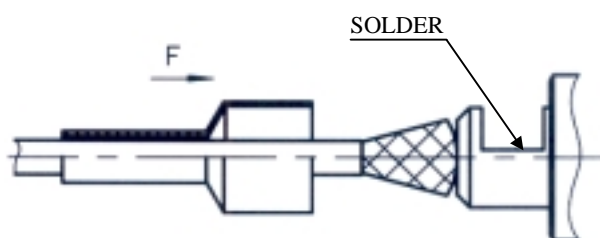

Fan the braid.
Push the connector body under the braid.
Slide the center contact on until it bottoms against the cable dielectric.
Solder the center contact.
Push the connector body under the braid.
Slide the ferrule over the braid in direction F.

Issue : 0042 B

In the effort to improve our products, we reserve the right to make changes judged to be necessary.

